

PVC curbs

Benefits

- ✓ Highly insulating
- ✓ Can be used everywhere – compatible with all types of roof membranes
- ✓ Beautifully finished
- ✓ Easy to maintain
- ✓ Lightweight and still very sturdy
- ✓ Fully recyclable
- ✓ Easy installation: The PVC curb is heat-resistant (keep the flame away from the curb of course) and remains intact while laying the roof covering
- ✓ Indoor sun blinds can be installed in any type of PVC curb
- ✓ All PVC curbs (except for 16/20 EP and type 35/30) can be fitted with a ventilation grid as from a light dimension of 80 x 80 cm

TECHNICAL DETAILS

Curbs	U _{up} value EN 1873:2014 (W/m ² K)
PVC 16/20 EP	0.89
PVC 16/00	1.00 *
PVC 20/00 EP & 20/00 EP-S	0.61
PVC 30/20	1.00 *
PVC 35/30	0.86

U_{up} value: U (upstand) or insulation value of the curb according to EN 1873:2014 and defined with EN 10077-2:2012
* according to EN 1873:2014 and defined with EN ISO 12567-2

Model

The **PVC curb is the basis for a fixed or openable plastic skylight, a hybrid or a glass skylight.** The opening system can be controlled manually or electrically for comfort ventilation. PVC curbs are also used for smoke extraction systems (Smoke and Heat Extraction) that can be controlled electrically or pneumatically.

An openable PVC curb (for ventilation) is provided with hinges and a standard PVC frame. You can also choose to install the insulating PVC frame EP or the super insulating PVC frame EP25. The skylight is installed on this structure.



CERTIFICATIONS: Skylux has CE marking in accordance with EN 1873:2014. Certain PVC curbs are CE certified and so form a compliant component of the Smoke and Heat Extraction systems in accordance with EN12101-2 and NBN S21-208-1 and 3.
Fire certificate: European classification E (EN 11925-2) and class M1

Types

1. Traditional application

PVC curb 16/20 EP

The 16/20 EP curb with an inventive interior structure is super-insulating. This curb is exceptionally strong and offers excellent performance for all traditional applications.

With the lining groove, you connect the ceiling finish seamlessly: allow 4 cm extra roof opening for this. A 16/20 PVC curb with daylight size B of 100 x 100 cm has a roof opening C of 120 x 120 cm if you make no use of the lining groove. Allow for a roof opening of 124 x 124 cm if you do make use of it.

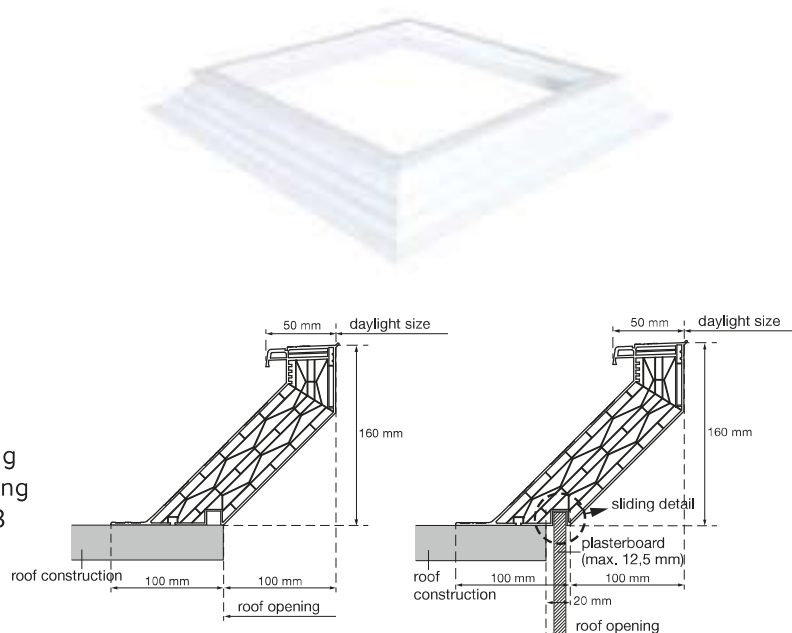

2. Ideal for renovations

PVC curb 16/00

The 16/00 curb provides the ideal solution when replacing vertical timber or metal curbs.

In a PVC 16/00 curb, a Skymax SHEV or Skylux 160° CE system can be provided, as long as a total curb height of at least 30 cm is respected.



PVC curb 30/20

Thanks to its height of 30 cm, the 30/20 curb offers the possibility of incorporating a package of roof insulation. The curb has also been specially designed to comply with the 30 cm minimum height of the smoke and heat extraction systems without extra carpentry. In a PVC 30/20 curb, a CE certified Skymax SHEV or Skylux 160° CE system can be provided in the vertical zone of the curb.



PVC curb 35/30

A curb that's easily installed over an existing curb. The height of the vertical part below measures 150 mm, which is ideal for insulation.

An extra wide lower flange of 150 mm is offered as an option. This lower flange increases the supporting surface and the possibilities to fix the curb.

A CE compliant SHE system, Skylux 160° CE, can be provided in the vertical part of the PVC 35/30 curb.

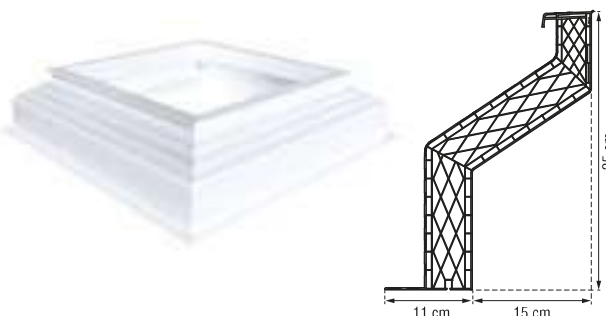

3. Super-insulating solution

PVC curb 20/00 EP (with bottom flange) and 20/00 EP-S (without bottom flange)

By installing the 20/00 EP-S curb on top of the 20/00 EP or another curb, you can define the height yourself, for instance depending on the insulation thickness on the roof. The PVC that is exposed to the outdoor environment is UV stabilised and of impact-resistant frame quality.

With the lining groove, you connect the ceiling finish seamlessly: allow 4 cm extra roof opening for this. A 20/00 EP PVC curb and a 20/00 EP-S curb with a 100 x 100 cm B daylight size has a 100 x 100 cm C roof opening if you make no use of the lining groove. Allow for a structural opening of 104 x 104 cm if you do make use of it.

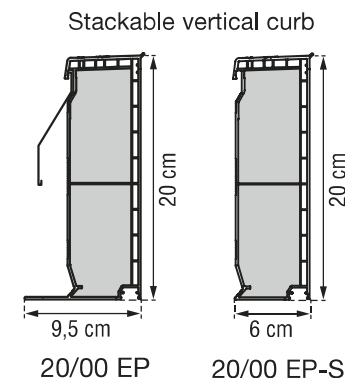

The 20/00 EP curb is provided with an anodised aluminium profile (skirt profile) with 4 plastic (ASA) corner profiles. Depending on the curb size, the aluminium profile is attached with stainless steel self-tapping screws. This allows you to easily pull up the roofing.

PVC curbs 16/20 EP

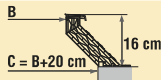
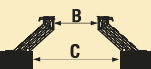
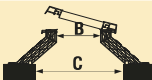
			
B DAYLIGHT SIZE	C = B + 20 ROOF OPENING	FIXED	OPENABLE*
40 x 40	60 x 60	€ 145 ●	€ 257 ↑
45 x 45	65 x 65	€ 154	€ 268 ↑
50 x 50	70 x 70	€ 162 ●	€ 281 ↑
55 x 55	75 x 75	€ 164 ●	€ 285 ↑
60 x 60	80 x 80	€ 175 ●	€ 303 ↑
70 x 70	90 x 90	€ 206 ●	€ 338 ↑
75 x 75	95 x 95	€ 218 ●	€ 352 ↑
80 x 80	100 x 100	€ 226 ●	€ 364 ↑
90 x 90	110 x 110	€ 240 ●	€ 386 ↑
100 x 100	120 x 120	€ 253 ●	€ 402 ↑
105 x 105	125 x 125	€ 273 ●	€ 426 ↑
110 x 110	130 x 130	€ 276 ●	€ 432 ↑
120 x 120	140 x 140	€ 296 ●	€ 459 ↑
130 x 130	150 x 150	€ 319 ●	€ 506 ↑
140 x 140	160 x 160	€ 343 ●	€ 536 ↑↑
150 x 150	170 x 170	€ 368 ●	€ 582 ↑↑
155 x 155	175 x 175	€ 385	€ 603 ↑↑
160 x 160	180 x 180	€ 395 ●	€ 619 ↑↑
170 x 170	190 x 190	€ 417	€ 646 ↑↑
180 x 180	200 x 200	€ 443 ●	€ 681 ↑↑
200 x 200	220 x 220	€ 476 ●	€ 729 ↑↑
40 x 70	60 x 90	€ 164 ●	€ 285 ↑
40 x 100	60 x 120	€ 206 ●	€ 338 ↑
40 x 130	60 x 150	€ 254	€ 395 ↑
40 x 160	60 x 180	€ 279	€ 439 ↑
40 x 190	60 x 210	€ 301	€ 477 ↑
40 x 220	60 x 240	€ 377	€ 575 ↑↑
40 x 280	60 x 300	€ 431	€ 668 ↑↑
45 x 75	65 x 95	€ 175	€ 299 ↑
45 x 105	65 x 125	€ 218	€ 351 ↑
50 x 70	70 x 90	€ 175 ●	€ 303 ↑
50 x 80	70 x 100	€ 201 ●	€ 330 ↑
50 x 100	70 x 120	€ 212 ●	€ 345 ↑
50 x 110	70 x 130	€ 218 ●	€ 356 ↑
50 x 140	70 x 160	€ 238 ●	€ 392 ↑
50 x 170	70 x 190	€ 265	€ 431 ↑
50 x 200	70 x 220	€ 283	€ 475 ↑↑
50 x 230	70 x 250	€ 309	€ 514 ↑↑
60 x 80	80 x 100	€ 206 ●	€ 338 ↑
60 x 90	80 x 110	€ 212 ●	€ 346 ↑
60 x 120	80 x 140	€ 240 ●	€ 386 ↑
60 x 130	80 x 150	€ 252 ●	€ 408 ↑
60 x 150	80 x 170	€ 268 ●	€ 431 ↑
60 x 180	80 x 200	€ 289	€ 466 ↑

↑ For single spindle

↑↑ For double spindle

● Available from stock

Other with delivery time of 10 working days

* You have to choose an opening system for the openable type (see page 85-86).

PVC curbs 16/20 EP (continued)

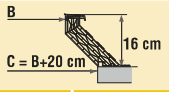
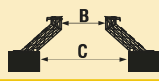
			
B DAYLIGHT SIZE	C = B + 20 ROOF OPENING	FIXED	OPENABLE*
60 x 200	80 x 220	€ 309	€ 504 ↑↑
70 x 100	90 x 120	€ 229 ●	€ 371 ↑
70 x 130	90 x 150	€ 253 ●	€ 412 ↑
70 x 150	90 x 170	€ 269	€ 434 ↑
70 x 160	90 x 180	€ 276 ●	€ 448 ↑
70 x 200	90 x 220	€ 311	€ 511 ↑↑
70 x 220	90 x 240	€ 329	€ 536 ↑↑
75 x 105	95 x 125	€ 254 ●	€ 400 ↑
75 x 125	95 x 145	€ 267 ●	€ 416 ↑
75 x 165	95 x 185	€ 289	€ 465 ↑
75 x 175	95 x 195	€ 309 ●	€ 500 ↑↑
75 x 225	95 x 245	€ 368	€ 581 ↑↑
80 x 110	100 x 130	€ 253 ●	€ 400 ↑
80 x 130	100 x 150	€ 273 ●	€ 436 ↑
80 x 140	100 x 160	€ 279 ●	€ 444 ↑
80 x 160	100 x 180	€ 309 ●	€ 485 ↑
80 x 170	100 x 190	€ 312	€ 503 ↑↑
80 x 180	100 x 200	€ 319 ●	€ 512 ↑↑
80 x 200	100 x 220	€ 343 ●	€ 547 ↑↑
80 x 220	100 x 240	€ 368	€ 579 ↑↑
80 x 230	100 x 250	€ 381	€ 596 ↑↑
80 x 250	100 x 270	€ 426	€ 663 ↑↑
80 x 280	100 x 300	€ 443 ●	€ 689 ↑↑
90 x 120	110 x 140	€ 273 ●	€ 431 ↑
90 x 150	110 x 170	€ 310 ●	€ 486 ↑
90 x 180	110 x 200	€ 329 ●	€ 526 ↑↑
90 x 210	110 x 230	€ 382	€ 593 ↑↑
100 x 130	120 x 150	€ 281 ●	€ 447 ↑
100 x 150	120 x 170	€ 314 ●	€ 504 ↑↑
100 x 160	120 x 180	€ 319 ●	€ 511 ↑↑
100 x 190	120 x 210	€ 359 ●	€ 564 ↑↑
100 x 200	120 x 220	€ 368 ●	€ 577 ↑↑
100 x 220	120 x 240	€ 395 ●	€ 612 ↑↑
100 x 230	120 x 250	€ 406	€ 625 ↑↑
100 x 250	120 x 270	€ 426 ●	€ 669 ↑↑
100 x 280	120 x 300	€ 442 ●	€ 694 ↑↑
105 x 165	125 x 185	€ 362	€ 557 ↑↑
105 x 225	125 x 245	€ 412	€ 631 ↑↑
110 x 140	130 x 160	€ 315	€ 492 ↑↑
110 x 170	130 x 190	€ 353 ●	€ 553 ↑↑
110 x 230	130 x 250	€ 412 ●	€ 637 ↑↑
120 x 140	140 x 160	€ 352	€ 533 ↑↑
120 x 150	140 x 170	€ 354	€ 549 ↑↑
120 x 180	140 x 200	€ 368 ●	€ 577 ↑↑

↑ For single spindle

↑↑ For double spindle

● Available from stock

Other with delivery time of 10 working days

* You have to choose an opening system for the openable type (see page 85-86).

PVC curbs 16/20 EP (continued)

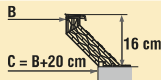
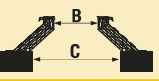
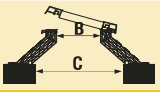
					
B DAYLIGHT SIZE	C = B + 20 ROOF OPENING	FIXED		OPENABLE*	
120 x 210	140 x 230	€ 405	●	€ 623	↑↑
120 x 240	140 x 260	€ 443		€ 672	↑↑
130 x 160	150 x 180	€ 357	●	€ 568	↑↑
130 x 190	150 x 210	€ 395	●	€ 619	↑↑
130 x 200	150 x 220	€ 406	●	€ 633	↑↑
130 x 220	150 x 240	€ 433	●	€ 670	↑↑
130 x 230	150 x 250	€ 449	●	€ 688	↑↑
130 x 250	150 x 270	€ 461	●	€ 717	↑↑
130 x 280	150 x 300	€ 533	●	€ 804	↑↑
145 x 170	165 x 190	€ 416		€ 635	↑↑
160 x 200	180 x 220	€ 443	●	€ 681	↑↑
160 x 220	180 x 240	€ 465		€ 711	↑↑
160 x 230	180 x 250	€ 472		€ 721	↑↑
160 x 250	180 x 270	€ 555	●	€ 826	↑↑
160 x 280	180 x 300	€ 575	●	€ 857	↑↑

↑ For single spindle

↑↑ For double spindle

● Available from stock

Other with delivery time of 10 working days

* You have to choose an opening system for the openable type (see page 85-86).